

95+ CRI White
Single Bin



- 22** 2150K • 95+ CRI **55** 5500K • 85+ CRI
- 24** 2350K • 95+ CRI
- 27** 2650K • 95+ CRI
- 30** 2950K • 95+ CRI
- 35** 3450K • 95+ CRI
- 40** 3950K • 95+ CRI

Colors

- R** Red **A** Amber
- B** Blue **G** Green

UL Class 2

IP20 Dry Location

Custom Cut to Fit

50,000 Hour Minimum Lifespan

Requires: Aion LED Driver, Approved Controller, AT, WT or ST Series Housing -Sold Separately, Not Included

Tested as suitable for use within clothing closet spaces by ETL/ Intertek

Must be installed in accordance with NEC 410.16 for use in clothing closet spaces



Component of a complete system including: Aion LED A-Track Light Engine, Aion LED A-Track housing with diffuser lens, & Aion LED driver (power supply). Dimmer not included. Approved dimmers, controls, power supplies, cable, & other components only. Contact Aion LED for questions regarding compatibility. Electrician installed. Strictly adhere to NEC & local building code. Limited 5-year warranty against manufacturing defects only, does not cover labor; voided by: inadequate ventilation, field modifications, installation by unqualified personnel, unapproved controls, drivers, cabling, other devices, not following installation guidelines & protocol, general negligence. Installer assumes all liability with regard to property & safety. This product is UL listed. See separate "Aion LED Warranty Terms" & additional instructional materials for more information. Authorized installers only. Systems tested prior to shipping.

PRELIMINARY SPECIFICATION, SUBJECT TO CHANGE WITHOUT NOTICE

9524-FR
Ultra High Output Luminaire with Rigid Board

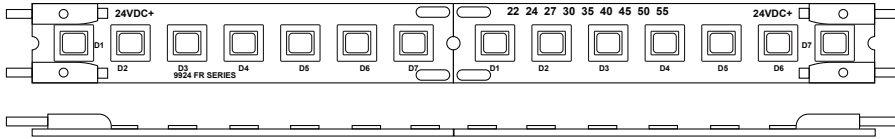

12W /ft.*
Up to 1,100 Lumens /ft.*

Rated lifetime:
50,000 hours min.

Available in 12" & 48"
connectible end to end

Minimum Increment: 4"

Also available:
9524-FRS Scored Rigid Board

	9524-22-FR	9524-24-FR	9524-27-FR	9524-30-FR	9524-35-FR	9524-40-FR	9524-55-FR
Total Lumens	840.13		1004.98	1047.29	1094.83	1117.04	
Input Power (W)	10.70		10.67	10.75	10.69	10.64	
Efficacy	79		94	97	102	105	
Color Rendering Index (CRI)	95		97	98	97	96	
R9	82.02		92.62	89.68	97.92	94.96	
Input Voltage (VDC)	24	24	24	24	24	24	24
Input Current (AMP)	0.45		0.44	0.45	0.45	0.44	
Correlated Color Temperature	2150K	2400K	2700K	2950K	3450K	3950K	5500K



PRELIMINARY SPECIFICATION, SUBJECT TO CHANGE WITHOUT NOTICE

Component of a complete system including: Aion LED A-Track Light Engine, Aion LED A-Track housing with diffuser lens, & Aion LED driver (power supply). Dimmer not included. Approved dimmers, controls, power supplies, cable, & other components only. Contact Aion LED for questions regarding compatibility. Electrician installed. Strictly adhere to NEC & local building code. Limited 5-year warranty against manufacturing defects only, does not cover labor; voided by: inadequate ventilation, field modifications, installation by unqualified personnel, unapproved controls, drivers, cabling, other devices, not following installation guidelines & protocol, general negligence. Installer assumes all liability with regard to property & safety. This product is UL listed. See separate "Aion LED Warranty Terms" & additional instructional materials for more information. Authorized installers only. Systems tested prior to shipping.